

STANDART YUVARLAK ÇUBUKLAR

Profil No	d	kg/m
1810	32	2,252
1809	8	0,141
1808	10,8	0,257
1807	65	8,993
1806	70	10,776
1805	60	7,917
1804	50	5,498
1803	40	3,519
1802	25	1,375
1801	16	0,563
1820	10	0,221
1822	12	0,317
1817	14	0,431
1814	14,7	0,475
1819	15	0,495
1827	18	0,690
1821	20	0,880
1815	22,2	1,084
1813	27,3	1,639
1828	28	1,669
1818	30	1,979
1816	35	2,694
1812	42,3	3,935
1825	45	4,310
1826	52	5,755
1811	53,8	6,365
1823	55	6,652
1840	75	11,972
1841	80	13,622
1833	90	17,240

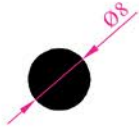

Profil No : 1809
Ağırlık : 0,141 kg/m

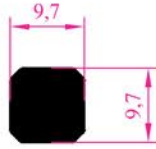

Profil No : 1848
Ağırlık : 0,249 kg/m

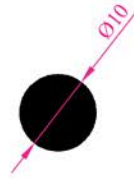

Profil No : 1820
Ağırlık : 0,221 kg/m

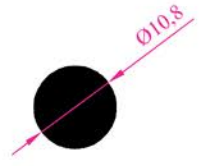

Profil No : 1808
Ağırlık : 0,257 kg/m

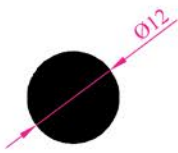

Profil No : 1822
Ağırlık : 0,317 kg/m

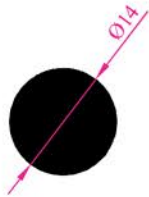

Profil No : 1817
Ağırlık : 0,431 kg/m

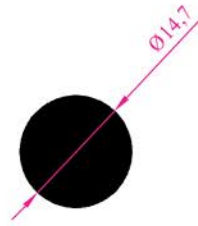

Profil No : 1814
Ağırlık : 0,475 kg/m

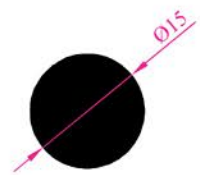

Profil No : 1819
Ağırlık : 0,495 kg/m

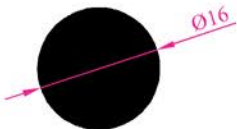

Profil No : 1801
Ağırlık : 0,563 kg/m

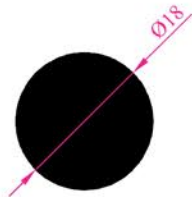

Profil No : 1827
Ağırlık : 0,690 kg/m

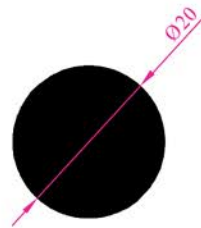

Profil No : 1821
Ağırlık : 0,880 kg/m

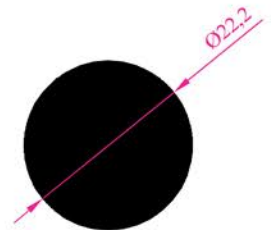

Profil No : 1815
Ağırlık : 1,084 kg/m

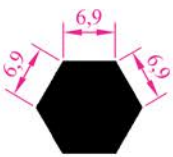

Profil No : 1831
Ağırlık : 0,338 kg/m

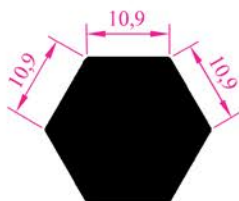

Profil No : 1832
Ağırlık : 0,847 kg/m

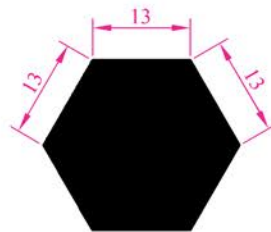

Profil No : 1824
Ağırlık : 1,229 kg/m

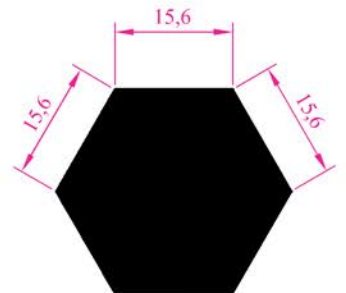

Profil No : 1830
Ağırlık : 1,711 kg/m

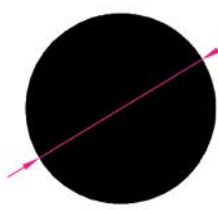

Profil N o :1802
Ag ırık :1,375 kg/m

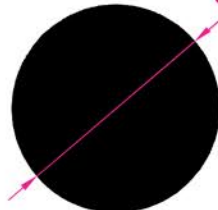

Profil N o :1813
Ag ırık :1,639 kg/m

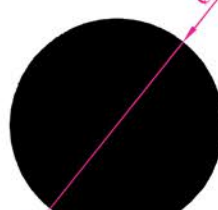

Profil N o :1828
Ag ırık :1,669 kg/m

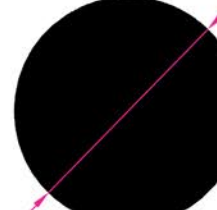

Profil N o :1818
Ag ırık :1,979 kg/m

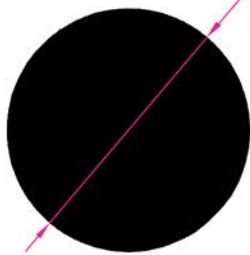

Profil N o :1810
Ag ırık :2,179 kg/m

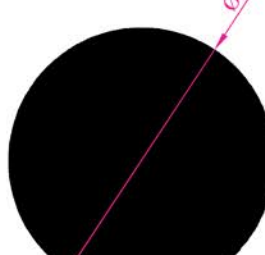

Profil N o :1816
Ag ırık :2,694 kg/m

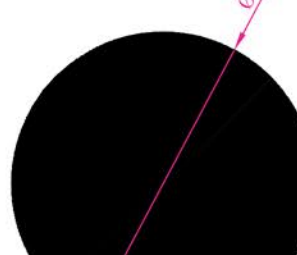

Profil N o :1803
Ag ırık :3,519 kg/m

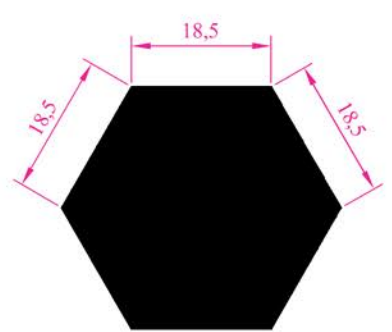

Profil N o :1838
Ag ırık :2,403 kg/m

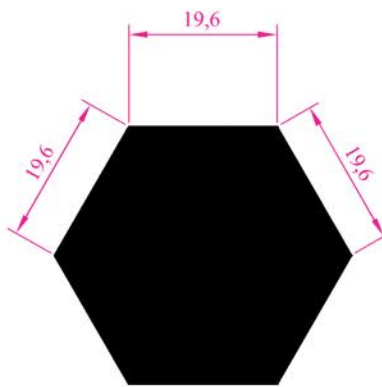

Profil N o :1836
Ag ırık :2,713 kg/m

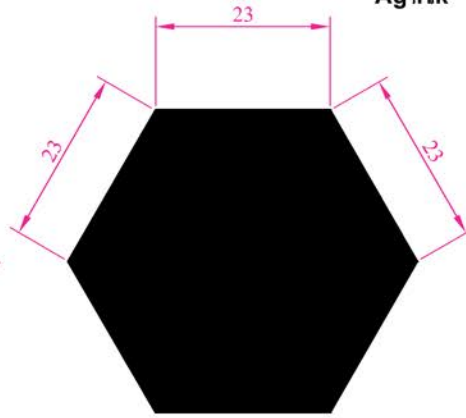

Profil N o :1837
Ag ırık :3,755 kg/m

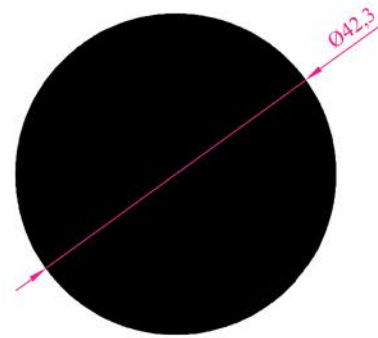

Profil N o :1812
Ag ırık :3,935 kg/m

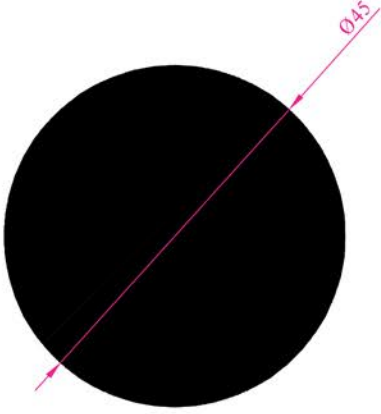

Profil N o : 1825
Ag ırık : 4,310 kg/m

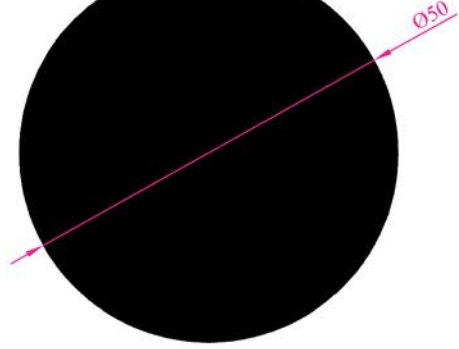

Profil N o : 1804
Ag ırık : 5,498 kg/m

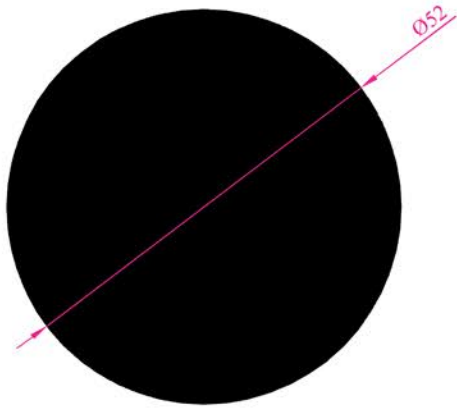

Profil N o : 1826
Ag ırık : 5,755 kg/m

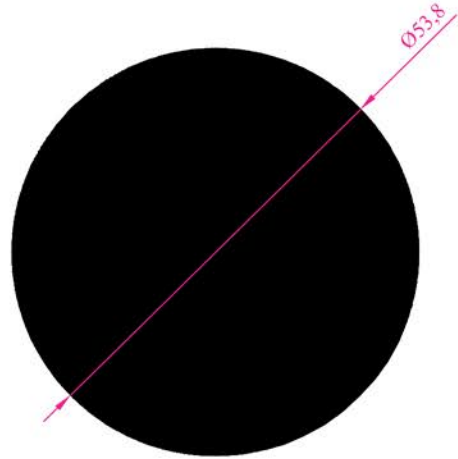

Profil N o : 1811
Ag ırık : 6,365 kg/m

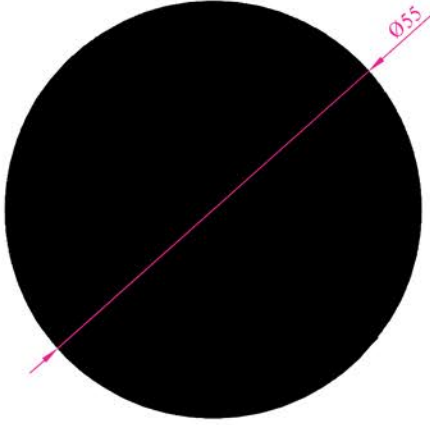

Profil N o : 1823
Ag ırık : 6,652 kg/m

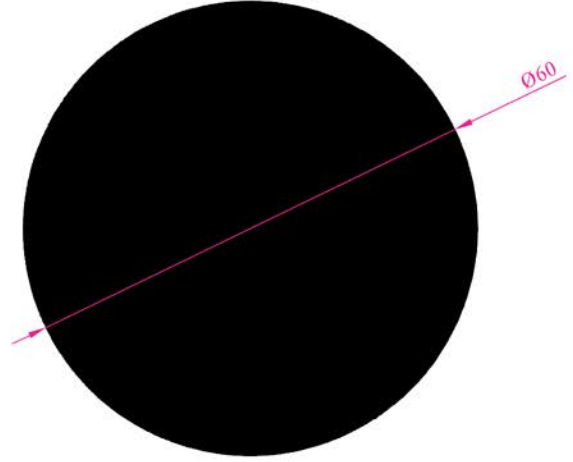

Profil N o : 1805
Ag ırık : 7,917 kg/m

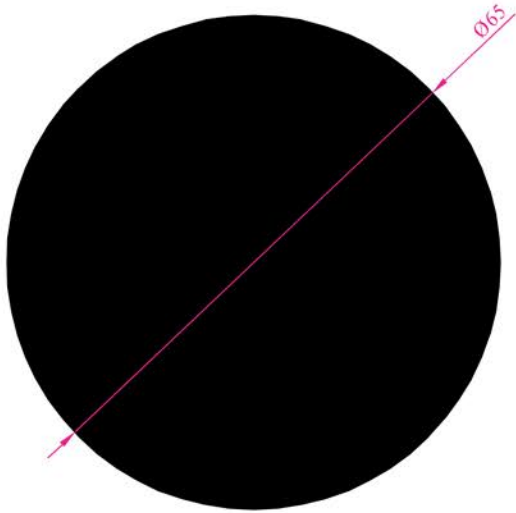

Profil N o : 1807
Ag ırık : 8,993 kg/m

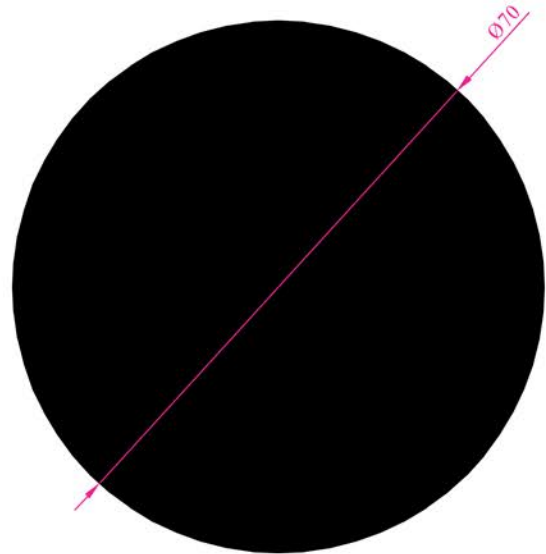

Profil N o : 1806
Ag ırık : 10,977 kg/m

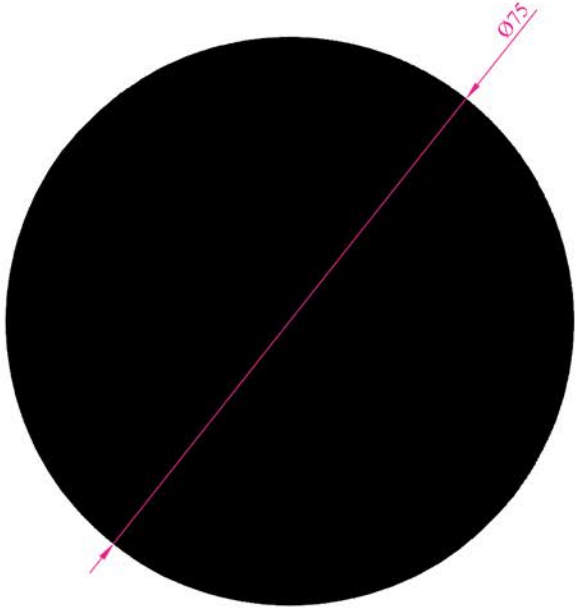

Profil N o :1840
Ağırlık :11,972 kg/m

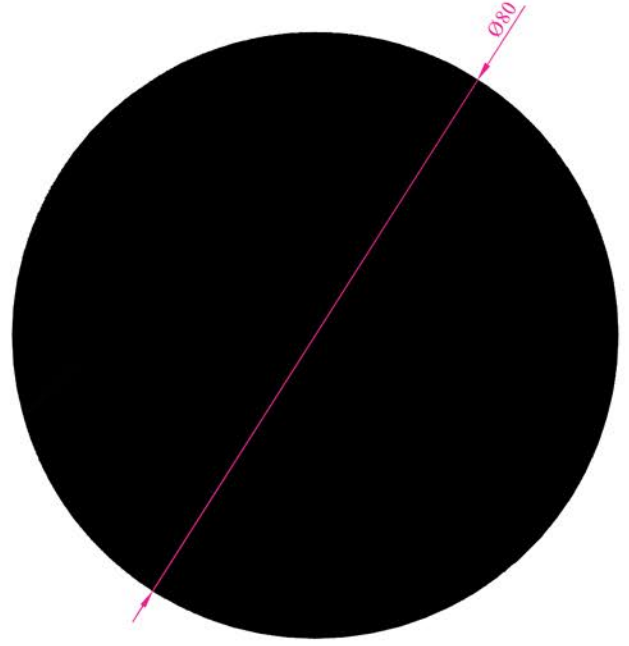

Profil N o :1841
Ağırlık :13,622 kg/m

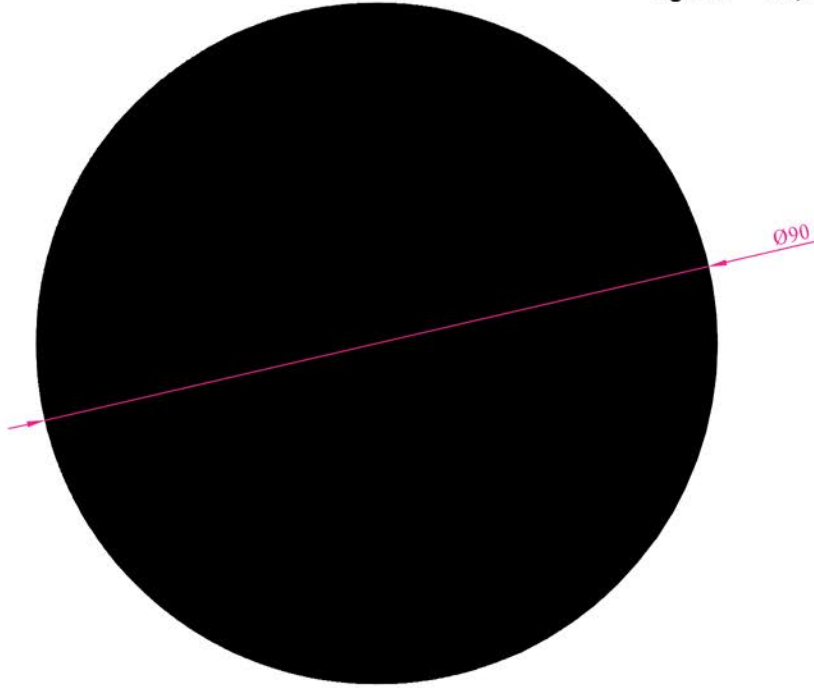

Profil N o :1833
Ağırlık :17,240 kg/m